

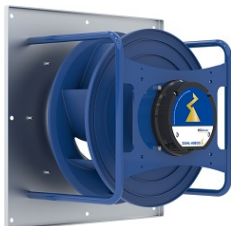

1



GR35C-ZID.DC.CR | 116171/A01 | Portfolio STD-WW | Cpro ECblue

Standard design with ECblue motor and integrated electronics

Material of impeller:

- ZAmid - high performance composite material

Color Coating:

- Color coating in RAL5002 (Ultra marine-blue)

Mains voltage motor size B_:

- 1~ 200...277 V; 50/60 Hz

Mains voltage motor size D_:

- 1~ 200...277 V; 50/60 Hz
- 3~ 200...240 V; 50/60 Hz
- 3~ 380...480 V; 50/60 Hz

Mains voltage motor size G_:

- 3~ 200...240 V; 50/60 Hz
- 3~ 380...480 V; 50/60 Hz

Thermal class:

- THCL155

Thermal protection:

- Protection with active temperature management

Protection:

- IP55

Coating:

- Motor painted in RAL5002 (Ultra marine-blue)

Controller (only motor size B_):

- Activation via external speed setting 0-10 V / PWM, Communication interface on request
- Standard cable length: 60 cm

Controller (only motor size D_, G_):

FANselect



- **BASIC:**

Activation via external speed setting 0-10 V / PWM Art. no. ER- and GR-module
in basic version

- **PREMIUM:**

Integrated control functionality, Communication interface on request

Cable glands:

- Motor size D: 3 x M16 x 1.5
- Motor size G: 3 x M20 x 1.5

Ambient temperature:

- Minimum permissible ambient temperature: -20 °C*
- Maximum permissible ambient temperature: 40 °C or see data sheet

***Continuous operation with occasional starts (S1) according to DIN EN 60034-1: 2011-02. Occasional starting between -35 ° C and -25 ° C is permissible. Permanent operation below -25 ° C only possible with special bearings for refrigeration applications on request.**



fan data

15/12/2021

version FANselect V 1.01 (211209), AMCA V 1.03 September, 2021 / 1.21.12.09 | 53567 | (user ZAFS43567)

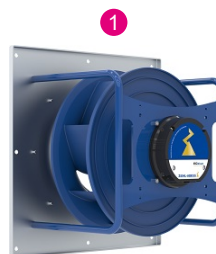

type	GR35C-ZID.DC.CR
article no.	116171/A01 Portfolio STD-WW

technical data

motor	ECblue
Efficiency class	IE5
mains supply	- 3~ 400V 50Hz
ambient temperature, max. limit (t_r)	°C 50
efficiency grade η_{statA}	% 68,6
efficiency grade N_{actual} N_{target}	74,9 62
ErP-conformity	2015 EC controller integrated
grille influence	no

fan data

SFP-class SFP-value (P_{SFP})	- Ws/m ³	4 1309
airflow volume (q_v)	ft ³ /min	3556.5
air velocity	ft/s	45.93
pressure, stat. (p_{sF}) tot. (p_F)	in.wg.	2.917 3.375
electrical power input (P_{sys})	W	2197
system eff., stat. ($\eta_{sF,sys}$) tot. ($\eta_{F,sys}$)	%	55.5 64.2
fan speed (n) max. (n_{max})	rpm	2967 2970
fan speed, set value (% n_{max})	%	100
frequency (f_{BP}) (f_{max})	Hz	50 60
voltage (U_{DP})	V	400
current (I_{DP})	A	3.36
acoustics, suction side ($L_{w(A),5}$) ($L_{w,5}$)	dB	83 87
acoustics, pressure side ($L_{w(A),6}$) ($L_{w,6}$)	dB	90 92
dimensions (w x h x d)	in	19.69 x 19.69 x 13.39
product weight (m_{pr})	lb	44.1
k-factor nozzle pres. (k)	-	121
differential pres. nozzle ($p_{sF \text{ nozzle}}$)	Pa	2494

PF:PF_50; Ano:116171; STot:+-10 %





performance curve / acoustics

15/12/2021

version FANselect V 1.01 (211209), AMCA V 1.03 September, 2021 / 1.21.12.09 | 53567 | (user ZAFS43567)

- 1 GR35C-ZID.DC.CR** measured in standard nozzle in installation type A according to ISO 5801
 116171/A01 | Portfolio measurement density 0.072 [lbs/ft³]
 STD-WWW

air performance p_{sF}

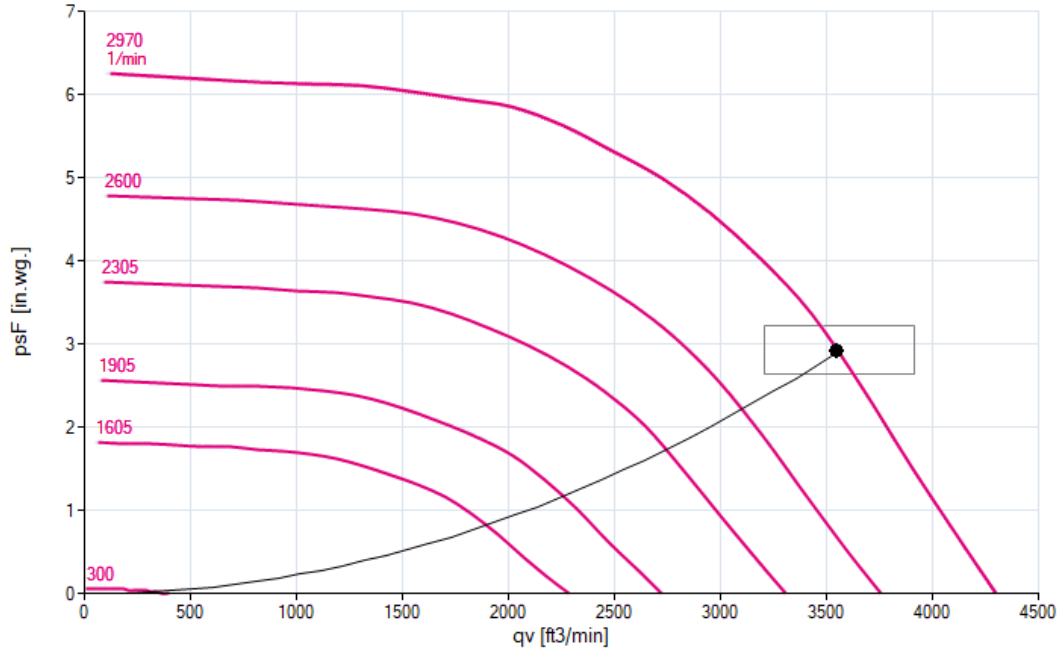

acoustics (L_{w(A),5})

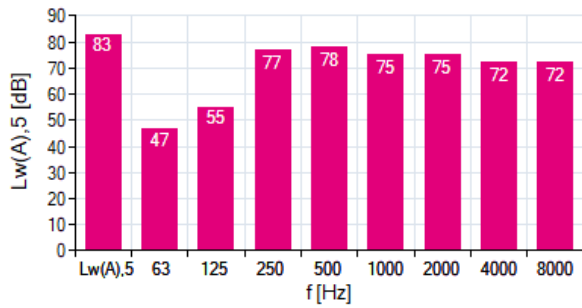

acoustics (L_{w(A),6})

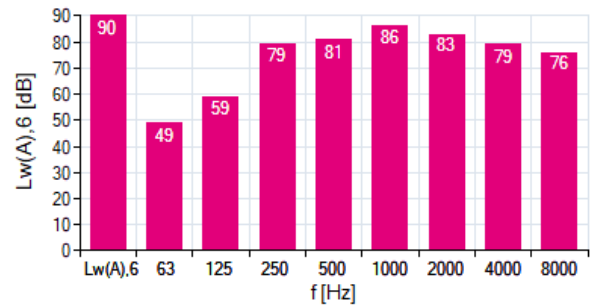

1 GR35C-ZID.DC.CR

f [Hz]	sum	63	125	250	500	1000	2000	4000	8000
L _{w(A),5}	83	47	55	77	78	75	75	72	72
L _{w,5}	87	72	71	83	81	75	74	71	74

f [Hz]	sum	63	125	250	500	1000	2000	4000	8000
L _{w(A),6}	90	49	59	79	81	86	83	79	76
L _{w,6}	92	74	74	86	84	86	82	78	78

FANselect



efficiency grade / power input 15/12/2021
version FANselect V 1.01 (211209), AMCA V 1.03 September, 2021 / 1.21.12.09 | 53567 | (user ZAFS43567)

① **GR35C-ZID.DC.CR** measured in standard nozzle in installation type A according to ISO 5801
 116171/A01 | Portfolio measurement density 0.072 [lbs/ft³]
 STD-WWW

efficiency grade $\eta_{F,sys}$

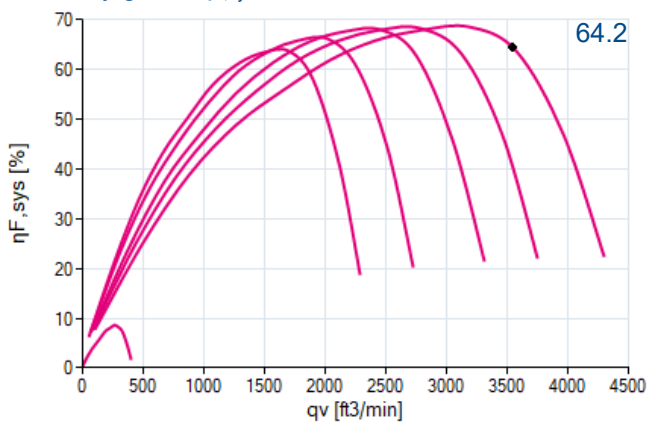

efficiency grade $\eta_{SF,sys}$

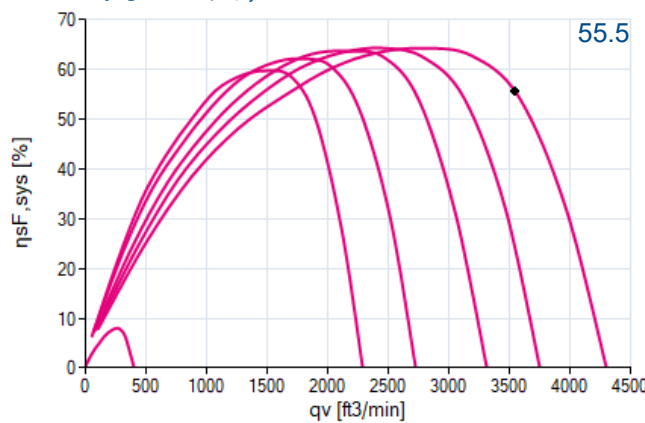

power input P_{sys}

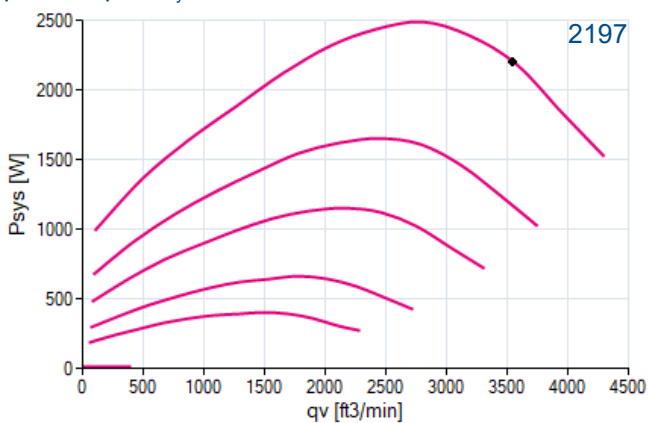



nominal values

15/12/2021

version FANselect V 1.01 (211209), AMCA V 1.03 September, 2021 / 1.21.12.09 | 53567 | (user ZAFS43567)

1

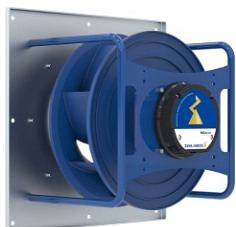

GR35C-ZID.DC.CR

116171/A01

3~ 380-480V 50Hz P1 2.50kW
 4.00-3.20A 2970/MIN 50°C
 3~ 380-480V 60Hz P1 2.50kW
 4.00-3.20A 2970/MIN 50°C
 IP55 THCL155

drawing

15/12/2021

version FANselect V 1.01 (211209), AMCA V 1.03 September, 2021 / 1.21.12.09 | 53567 | (user ZAFS43567)

1

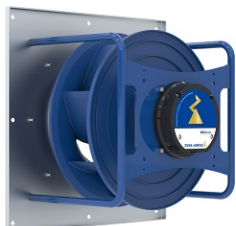

GR35C-ZID.DC.CR

116171/A01

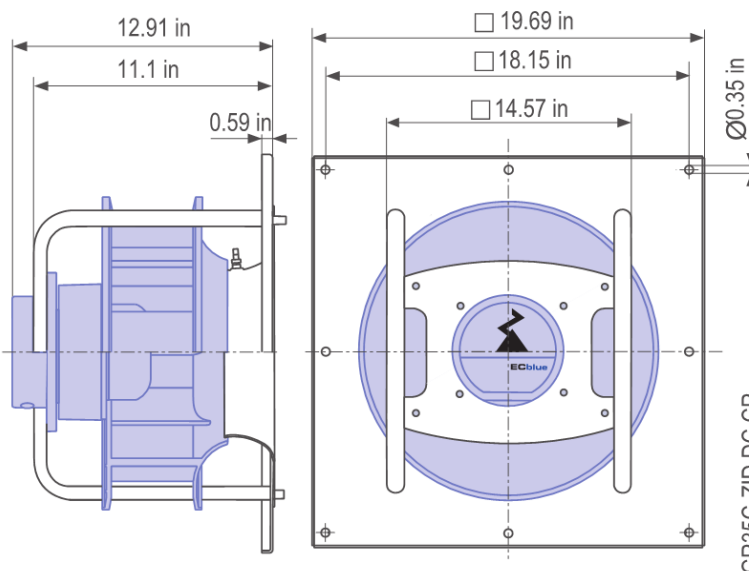

wiring diagram

15/12/2021

version FANselect V 1.01 (211209), AMCA V 1.03 September, 2021 / 1.21.12.09 | 53567 | (user ZAFS43567)

1

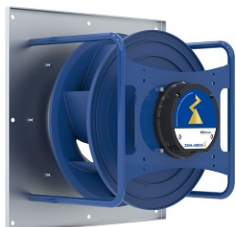

GR35C-ZID.DC.CR

116171/A01

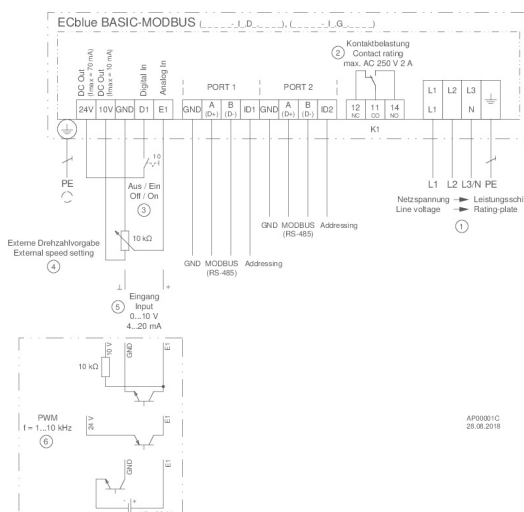



system components

15/12/2021

version FANselect V 1.01 (211209), AMCA V 1.03 September, 2021 / 1.21.12.09 | 53567 | (user ZAFS43567)



type	GR35C-ZID.DC.CR
article no.	116171/A01